

THE OFFICIAL

OUTDOOR HEATING PLANNING GUIDE



EXTEND THE OUTDOOR EXPERIENCE

A well-designed outdoor heating solution will extend the outdoor experience year-round by providing an added element of warmth and comfort.



Uninformed designers might rely on firepits or fire rings as a main source of heat. While these elements might be visually appealing, firepits or other fire features do not provide sufficient heating. The use of engineered outdoor heaters are necessary to keep the outdoor entertainment space usable all year long.

Commercial clients such as restaurants, hotel rooftop bars, outdoor co-working spaces, cruise ships, yachts, casinos and others with outdoor areas look to capitalize on these areas by creating comfortable and efficient heating systems that encourage extended social interaction year round.

UNDERSTANDING THE CHALLENGES

Since an outdoor area is not a confined space by walls and roof structure, forced air systems are not effective in controlling the ambient temperature.

In an outdoor environment, hot air rises and quickly dissipates. Even the slightest breeze will diminish the effect of heating system, making a forced air heating system impossible

YOU CANNOT THERMOSTATICALLY CONTROL OUTDOOR HEATING.



THE SOLUTION

The only way to heat an outdoor area is through radiant heat. Radiant heat warms objects, not the air, similar to the experience of the sun warming your skin.

Because radiant heat focuses on objects and not air, radiant heaters are wind resistant and can still warm people even in mild wind conditions. This method involves projecting infrared heat radiation onto people rather than moving warm air into the outdoor patio.

Radiant heating is the foundation for all Bromic heaters. When properly specified, Bromic can heat any outdoor space more effectively than many of our competitors because of this principle.

STEP 01: DEFINE YOUR OUTDOOR SPACE



Outdoor areas are defined as being least 30% open (front, back or side walls). If a patio is partially covered, then it can capture heat inside the structure, also known as a heat cloud, creating a convectional heating effect.

Understanding the structure in design and engineering helps dictate the type and amount of heating required.

Considerations to be aware of:

- Seasonal changes in your geography
- Proximity to water
- Proximity to air flow or wind direction
- New or existing construction
- Building Codes
- Clearances
- Energy sources

EXAMPLES

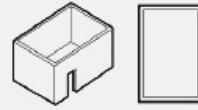

- 01** An enclosure with walls on all sides, but at least one permanent opening at ground level and no overhead.



- 02** An area with two permanent openings and an overhead cover.

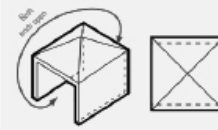

- 03** Another variation to an area with two permanent openings and an overhead cover.

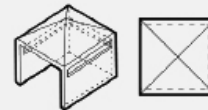

- 04** Within a partial enclosure which includes an overhead cover and three side walls. As long as 30% or more of the horizontal periphery of the enclosure is permanently open.

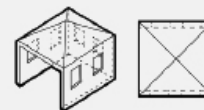

- 05** Another variation of Example 4 with minimum open space requirements.

STEP 02: UNDERSTANDING THE TYPES OF HEAT

Manipulating direction of heat is a critical factor in designing your outdoor heating solution. The most effective heaters use directional heating elements for efficient energy usage and to avoid over-heating guests.

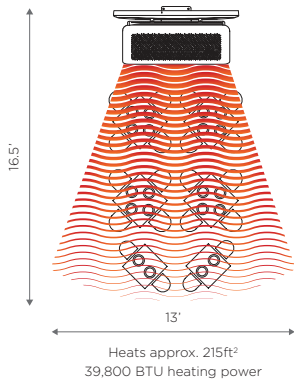

Direct heat is a mixture of short and medium wave technology, which produces the highest levels of efficiency.

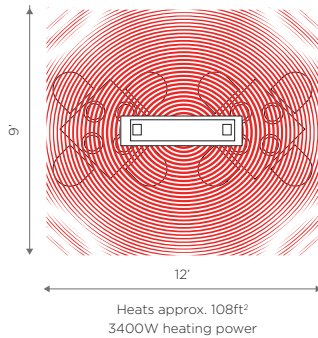

This is a mixture of medium and long wave technology. Indirect heat does not produce a high radiant heat property, so it has lower efficiency levels, and is more susceptible to wind and external factors.

Heaters using indirect heat have a slower heat up time than direct heaters.



Directional heat implies that the majority of the heat produced is pushed in one direction, allowing for better heat coverage.



Non-Directional heat pushes the warmth evenly in all directions.

HEAT TRANSFER FUNDAMENTALS

Outdoor heaters utilize one of two different methods to transfer thermal energy:

- 01 CONVENTIONAL HEAT**
Emits hot air that mixes with ambient air to raise the average temperature of an area.
- 02 INFRARED HEAT**
Heats target objects themselves as they come into contact with waves of infrared light.

Note: Infrared radiant heat is considered the most effective and energy efficient heat source for alfresco areas. This factors into green energy and sustainable design considerations.



STEP 03: ELECTRIC OR GAS?

When it comes to powering your heaters, there are three traditional types of fuels: Natural Gas, Liquid Propane (Portable), and Electric. While each fuel has its respective pros & cons, here are three main factors to consider:

1. Space confinement and design
2. Availability of utilities
3. Cost of operations

GAS HEATERS



- Long wave
- Indirect and non-directional heat



- Short and medium wave
- Direct and directional heat
- LPG

ELECTRIC HEATERS

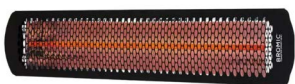

- Short to medium wave
- Direct heat
- Quartz element



- Long wave
- Indirect and non-directional heat
- Industrial element



- Medium wave
- Directional heat
- Carbon element



- Long wave
- Indirect and non-directional heat
- Halogen element



STEP 04: HEAT WAVE MAPPING FOR PROPER COVERAGE

	HEAT SOURCE	RADIANT EFFICIENCY	HEAT DISTRIBUTION	WARM UP TIME	
Long Wave	Low (unit produces 572°F)	Least Efficient: 40% radiant heat and 60% convective bi-product	Susceptible to wind dispersal	Average 5 Minutes	
Medium Wave	Moderate (unit produces 1652°F)	60% radiant heat and 40% convective bi-product	Limited susceptibility to wind	Average 30 Seconds	
Short Wave	High (unit produces 3992°F)	Most Efficient: 90% radiant heat and 10% convective bi-product	Warms people and objects directly	Instantaneous	

RECOMMENDED APPLICATIONS REFERENCE GUIDE

RECOMMENDED APPLICATIONS	NATURAL GAS	PROPANE	ELECTRIC
Indoor			✓
Outdoor	✓	✓	✓
Gaming	✓		✓
Hospitality	✓	✓	✓
Residential	✓	✓	✓
FEATURES			
Low clearance			✓
High clearance	✓		
Flush mounting			✓
Area heating	✓	✓	
Spot heating			✓
Floor space needed		✓	
Heat adjustment option		✓	✓
Portable		✓	
Ceiling or wall mounted	✓		✓
Installation required	✓		✓
Ventilation required	✓	✓	
Works in cold climates <5°C	✓	✓	
Airflow Needed	✓	✓	

The above table is for reference only. Please contact Bromic Heating for specific application design.

[VIEW BROMIC HEATERS ONLINE](#)

STEP 05: DETERMINE THE LONG TERM NEEDS

ESTIMATED COST TO RUN 200 FT² COVERAGE FOR OUTDOOR PATIO

NATURAL GAS	PROPANE	ELECTRIC
\$0.40/h	\$2.50/h	\$0.88/h

These figures are a basic reference guide and will change depending on your geography and application.

For example, for a patio size 20' x 10' in California, we recommend 2 x 500 series gas heaters. In colder states, such as Massachusetts, the design may change to 3 x 500 series heaters for the same size patio.

Different geographies will have different ambient temperatures and may require more or less heaters depending on the ambient variances. Properly incorporating geography, application and seasonality in the specification is critical for long term effectiveness and cost efficiency.

COVERAGE AREA BY BROMIC PRODUCT

HEATER	COVERAGE AREA
Platinum Gas	160 - 215 ft ²
Platinum Electric	65 - 108 ft ²
Tungsten Gas	160 - 215 ft ²
Tungsten Electric	65 - 108 ft ²
Tungsten Portable	215 ft ²

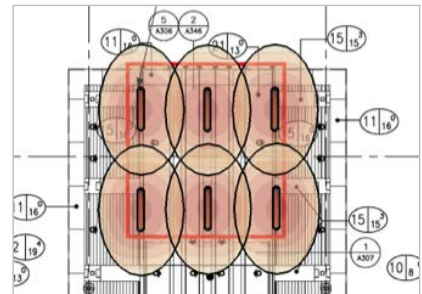

Planning For An Outdoor Pool



STEP 06: BUILDING CODE COMPLIANCE

It is a requirement by law to have heaters that match the standards and regulations set out by the US Building Code.

GAS HEATERS

USA: ANSI Z223.1/NFPA 54

These standards cover topics such as: where heaters can and cannot be installed, the requirements of different power supplies, air flow, ventilation needs, and the required clearance from combustibles.

ELECTRIC HEATERS

USA: ANSI/NFPA 70

Specifically, heaters installed on a wall must be installed 72" (6') off the floor level and ceiling mounted minimum clearance to be 96" (8'). This clearance from ceiling however varies, dependent on energy output.

COMPLIANCE: INTERTEK/UL/CSA

Gas and electrical appliances (including portable heaters) are required to be certified and exhibit a certification mark.

*The codes mentioned are indications only of the regulations which need to be considered when building an outdoor space. Builders and owners need to ensure they check with local building authorities to ensure compliance.



STEP 07: MOUNTING & INSTALLATION COSTS

How you mount your heater is just as critical to the aesthetic design as it is to the functional output of the heater. Bromic has created a variety of different mounting options for seamless integration with the outdoor space and heat deflection to maximize heat output.

BROMIC MOUNTING KITS

Bromic Heater Recess Kits

- Seamlessly integrate your units with these unique recess kits which permit flush-mounting in roof cavities.
- Connects to Platinum & Tungsten Electric heaters

Bromic Heating Suspension Poles

- Space units down to an effective height in higher-ceiling applications where wall-mounting may not be appropriate.
- Connects to Platinum & Tungsten Electric heaters

Bromic Heat Deflector

- Dual-layer stainless steel deflectors that significantly reduce the clearance needed between the top of a heater and the surface above it by absorbing heat that would otherwise escape vertically.
- Connects to Platinum & Tungsten Gas heaters

Bromic Heater Ceiling Poles

- Mount two heater units back-to-back beneath flat or pitched ceilings.
- Connects to Platinum & Tungsten Gas heaters

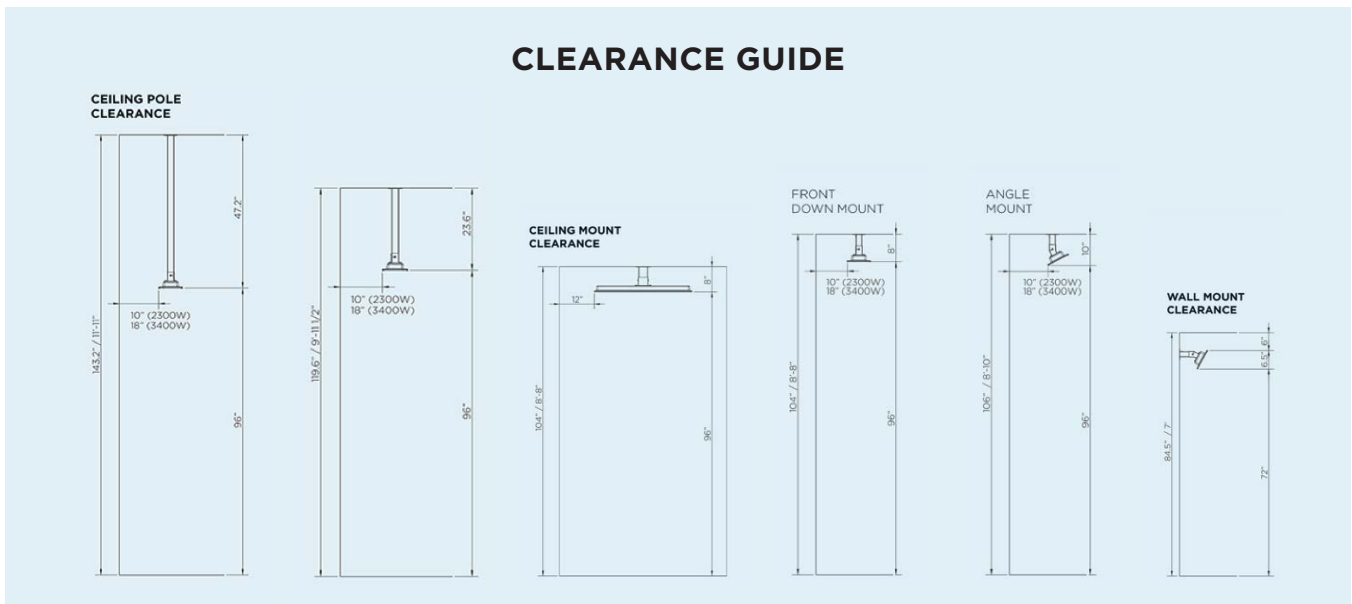



When pricing your outdoor heating solution, it is important to factor the professional installation costs that will be required to turn the design into a reality.

HEAT ANY OUTDOOR SPACE EFFECTIVELY WITH RADIANT HEATING

Once all the ventilation, recessing and clearance requirements have been mapped out, an all-encompassing quote will help manage expectations. Be sure to include the hardware, utilities, permit fees and any other expenses that may be required.

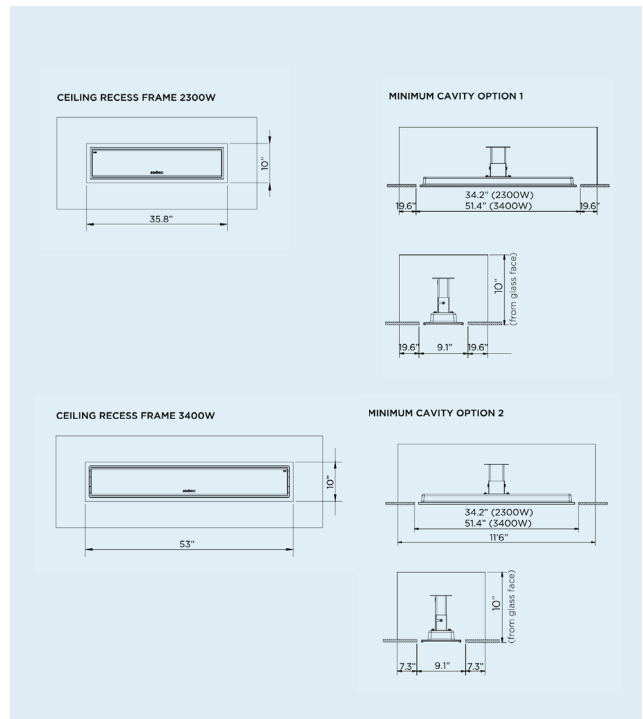

OPTIONAL STEP 08: CONTROLLERS & ACCESSORIES

Bromic heaters can be matched with a number of optional accessories and controllers. Consider the practical implications of how the heating will be controlled to fully benefit from the outdoor lifestyle.

GAS	ELECTRIC	HOME AUTOMATION
<ul style="list-style-type: none"> • On/Off Only • Wireless • Wall switch 	<ul style="list-style-type: none"> • On Off • Dimmed • Wireless • Wall switch • Voltage for commercial sites (208V/240V/277V) • Timer 	<ul style="list-style-type: none"> • Lutron • Crestron • Control4 • Nomad • BCS (Building Control Systems)





COMPLIMENTARY DESIGN SUPPORT

Our design specialists can help evaluate your design and application to recommend the most suitable heating configuration including product selection, placement and provide you with technical coverage drawings.

Submit photos, plans, or architectural drawings to take complete advantage of our design team.

Have peace of mind knowing that your outdoor heating designs are being installed in the right locations and will deliver optimum levels of heating efficiency.

Bromic Heating has supplied solutions for every conceivable application including luxury yachts, high end hotels, expansive apartment construction, pools, restaurants, shipping and receiving, warehouse and every residential application that you can think of.

**LEARN MORE
ABOUT OUR FREE
DESIGN SERVICE**

1-800-301-1293
[bromic.com/us](https://www.bromic.com/us)

CONTACT US

V1.2-10/2021