

Reference Manual

Solaira

Alpha H3

(Triple Emitter - Candel Range)

CANADA & USA MODELS:

SALPHAH3-30240LL-C (208V - 2250W / 240V - 3000W)
SALPHAH3-45240LL-C (208V - 3375W / 240V - 4500W)
SALPHAH3-60240LL-C (208V - 4500W / 240V - 6000W)

C = COLOR CODE

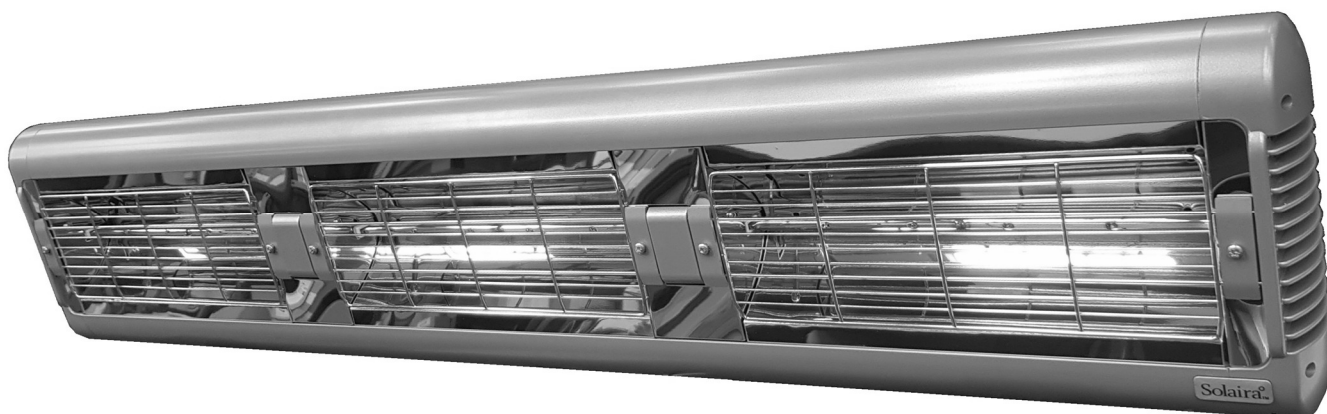

**WEATHERPROOF INFRARED HEATERS SUITABLE FOR OUTDOOR AND
INDOOR USE - RESIDENTIAL (OUTDOOR USE ONLY), COMMERCIAL AND
INDUSTRIAL USE IN NON-HAZARDOUS AREAS** ⚠️ 🔥 ⚡



INFOSIGHT CONSUMER PRODUCTS INC.

125 Traders Blvd. E Unit # 4, Mississauga, Ontario L4Z 2H3

Tel: 905-568-7655 - Fax: 905-568-7521

Email: info@solairaheaters.com - Website: www.solairaheaters.com

⚠️ IMPORTANT - SAVE THESE INSTRUCTIONS FOR FUTURE REFERENCE



IMPORTANT INSTRUCTIONS



When using electrical INFRARED HEATERS, basic precautions should always be followed to reduce the risk of fire, electric shock, and injury to persons, including the following:

1. **Read all instructions before using this heater.**
2. Use this heater only as described in this manual. Any other use not recommended by the manufacturer may cause fire, electric shock, or injury to persons.
3. This heater is hot when in use. To avoid burns, do not let bare skin touch hot surfaces. If provided, use handles when moving this heater. Keep combustible materials, such as furniture, pillows, bedding, papers, clothes, and curtains at least 6 feet (1.8m) from the front of the heater and keep them away from the sides and rear.
4. Extreme caution is necessary when any heater is used by or near children or invalids and whenever the heater is left operating and unattended.
5. Do not operate any heater with a damaged cord or after the heater malfunctions, has been dropped or damaged in any manner. Return heater to authorized service facility for examination, electrical or mechanical adjustment, or repair.
6. This heater is not intended for use in bathrooms, laundry areas and similar locations. Never locate heater where it may fall into a bathtub or other water container.
7. To disconnect heater, turn controls to off.
WARNING - Each power supply circuit shall be provided with disconnecting means and the disconnecting means shall be grouped together.



IMPORTANT INSTRUCTIONS



8. Do not insert or allow foreign objects to enter any opening as this may cause an electric shock or fire, or damage the heater.
9. To prevent a possible fire, do not block openings in any manner.
10. A heater has hot parts inside. Do not use it in areas where gasoline, paint, or flammable liquids are used or stored.
11. Do not cover or otherwise obstruct the heater.



SAVE THESE INSTRUCTIONS



GROUNDING INSTRUCTIONS

For 240 (or 208) volt heaters. The cords from each terminal box must be hard wired.



WARNING: RISK OF FIRE



Keep combustible material such as furniture, papers, clothes and curtains at least 6 feet (1.8m) from the front of the heater and away from the sides and rear.

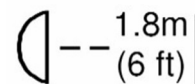



INTRODUCTION

The Alpha H3 heater produces radiant heat like the sun, warming people and objects rather than the air in between. It is mounted on an adjustable bracket that allows the heat to be directed exactly where it is required. The Alpha H3 can also be used in a modular system in that more than one heater can be connected together - see 'Configurations' later in the manual. The Alpha H3 weatherproof heater is designed for indoor and outdoor use.

Please read the following instructions carefully before use. The safety of this heater is guaranteed only by its correct usage in accordance with these instructions, therefore they should be retained for future reference.

CAUTION

Before using this appliance:

1. Check that the voltage indicated on the units rating label corresponds to the mains supply voltage.
2. Do not install the heaters less than the minimum height from the floor as specified below in the specification - Table. 1.
3. Ensure that the heater has been securely fastened in its final mounting position.
4. **WARNING** - This appliance must be grounded and hard wired! 
5. **WARNING** - Keep the mains cable away from the body of the heater which will get hot during use.
6. Do not cover or obstruct the heater while it is in use.
7. Do not insert any object through any slot or opening in the heater.
8. Do not use if guard is not present.
9. When replacing the emitter or cleaning the unit, ensure that the hard wired circuit(s) is disconnected from the mains supply. **Note:** always ensure that the emitter is cool before handling.
10. Do not handle the halogen emitter with bare hands. If it is inadvertently touched, remove finger marks with a soft cloth and methylated spirit or rubbing alcohol. Otherwise, the marks will burn into the quartz emitter during use causing premature heater failure. 
11. The heater is not intended for use by young children and must be supervised by a responsible person at all times. 

SPECIFICATION

Table 1. Canada and USA Heaters

No. of Units x Model Type	1 x SALPHAH3-30240/LL-C	1 x SALPHAH3-45240/LL-C	1 x SALPHAH3-60240/LL-C	2 x SALPHAH3-30240/LL-C	2 x SALPHAH3-45240/LL-C	2 x SALPHAH3-60240/LL-C
Voltage (Volts)	208 / 240					
No. of Emitters x Power (Watts)	3 x 750 / 1000	3 x 1125 / 1500	3 x 1500 / 2000	6 x 750 / 1000	6 x 1125 / 1500	6 x 1500 / 2000
Total Power of Unit (Watts)	2250 / 3000	3375 / 4500	4500 / 6000	4500 / 6000	6750 / 9000	9000 / 12000
Current (Amps) per Emitter	3.6 / 4.2	5.4 / 6.3	7.2 / 8.3	3.6 / 4.2	5.4 / 6.3	7.2 / 8.3
Total Current (Amps) of Unit	10.8 / 12.5	16.2 / 18.8	21.6 / 25.0	21.6 / 25.0	32.5 / 37.5	43.3 / 50.0
Min. Mounting Height From Floor	98¼ in (250 cm)	98¼ in / 108 in (250 cm / 274 cm)	108 in / 120 in (274 cm / 305 cm)	132 in / 158 in (335 cm / 401 cm)	158 in / 177 in (401 cm / 450 cm)	158 in / 177 in (401 cm / 450 cm)
Min. Distance From Ceiling	19½ in (50 cm)					
Min. Distance From Side Wall	39½ in (100 cm)					
Dimensions - W x H x D (inc. bracket & bars max pos.)	47½ in x 9 in x 12¾ in (120 cm x 23 cm x 32 cm)					
Weight	17.6 lb (8.0 kg)					
	35.2 lb (16.0 kg)					

▲ WARNING - RISK OF FIRE: Heaters rated at 208 / 240 Volt, 2 Kilowatt and above are not intended for use as indoor residential or as a household heater but maybe used for commercial/industrial use.

CONFIGURATIONS

The Alpha H3 heater is a triple emitter - it contains three emitters. It can be installed as a single unit or joined to another single unit. Joining bars are available that connect the heaters together to increase the size and output of the installation. The maximum number of units that can be joined together is two. Please read the section 'joining heaters together' for information on how this should be done.

INSTALLATION

The 208 / 240V version of the heater is fitted with 3 × supply cords measuring 79 inches (200 cm) for hard wiring.

⚠ WARNING: Wiring procedures and connections should be in accordance with the National Electric Code (NEC) and local codes.

⚠ WARNING: If the supply cord(s) becomes damaged, it must be immediately replaced by a qualified person in order to avoid a hazard.

⚠ CAUTION: Disconnect electric power supply before working on circuit wiring to prevent electric shock.

⚠ CAUTION: Please observe the minimum safe distance between the heater body and any inflammable surfaces.

⚠ CAUTION: When the electrical connection is outside weatherproof sockets must be used having ground fault protection (GFCI or GFI).

! NOTE: CONSULT A QUALIFIED ELECTRICIAN, IF IN DOUBT.

MOUNTING - 1 x TRIPLE (3 x EMITTERS) UNIT

⚠ CAUTION ⚠
Switch off/unplug the heater from the mains supply when mounting or adjusting the heater position.

- The Alpha H3 heater should only be wall mounted in a horizontal manner or hung from a ceiling from chains (not supplied).
- When wall mounting the Alpha H3 heater, do not position the heater at an angle more than 50° and less than 30° as shown in Fig. A.
- When ceiling hanging the Alpha H3 heater, ensure the minimum distance from the ceiling is adhered to as shown in Fig. B.

Continued on next page...

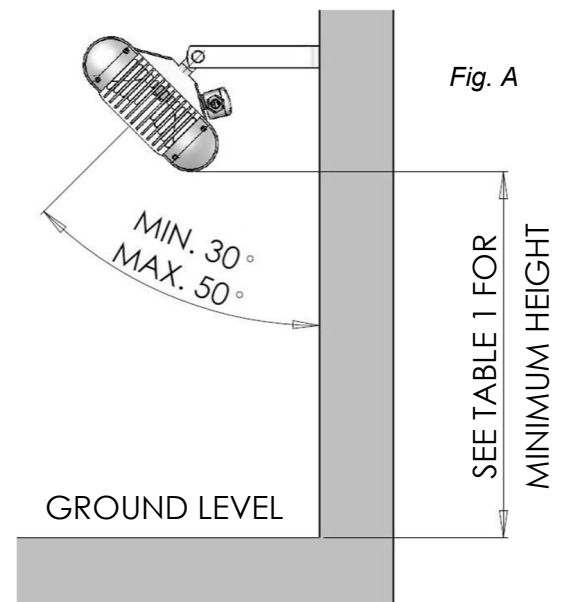

- Always allow the heater to cool before attempting to reposition/move. Never attempt to move the heater while it is switched on!
- Observe the minimum safe distance between the heater body and inflammable surfaces and objects when mounting.
- Please refer to Table 1 for the recommended positioning of the heater with regards to minimum distances. Do not install the heater in a corner!
- Keep out of the reach of children.

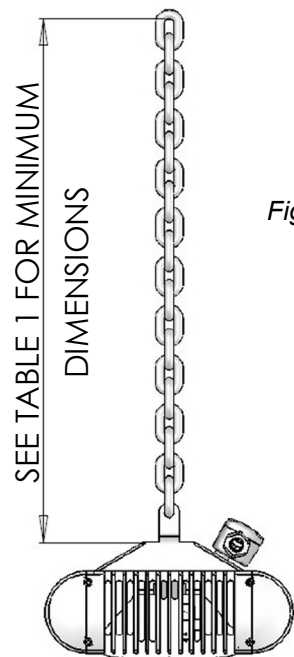

Fig. B

1. When wall mounting, securely fasten the L-shaped wall brackets to the mounting surface using both of the fixing holes in the short part of the bracket (see Fig. D for mounting hole centres). Please refer to Table 1 for recommended positioning of the heater. Please note, wall fixings are not supplied. They should be selected to substantially support the weight of the installation. If in doubt contact a professional for advice! When hanging from a ceiling two equal length and gauge chains are required and should be selected with fixings that are adequate to hold the weight of the heater. Again, if in doubt contact a professional for advice!

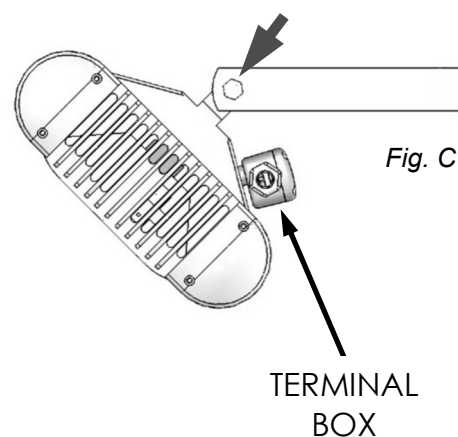

Fig. C

2. The heater should be mounted with the terminal box at the bottom of the heater when being wall mounted.

3. When wall mounting, fix in the required angular position by tightening the fixing bolts on the brackets at the rear of the heater as shown in Fig. C. The heater should face directly down when hanging.

4. Secure the supply cable so it is not resting on the body or obstructing the air-vents.

Always isolate the heater from the mains supply when adjusting the position.

DRILLING HOLE TEMPLATE DIMENSIONS FOR WALL MOUNTED BRACKETS

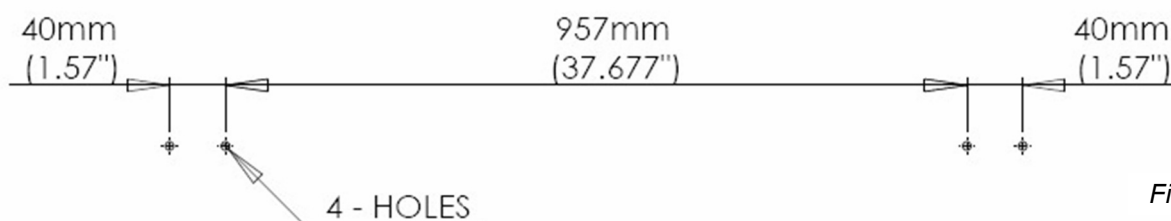

Fig. D

ASSEMBLING - 2 × TRIPLE (3 × EMITTERS) HEATERS JOINED

1. Take the first heater and place it face down on a flat surface.
2. Take the second heater and place it face down and positioned parallel to the first heater.
3. Push the bolts used to hold the wall brackets through the hole in the brackets on the rear heaters and slide a shake-proof washer on all the threads from the protruding side.
4. Slide the joining bars on each bolt and fit a washer and nut – do not fully tighten at this point.
5. Ensure the second heater is still parallel to the first and sitting flat.
6. Slide the joining bars on each protruding bolt of the other heater to connect them together and fit the washers and nuts.
7. Again, ensuring the heaters remain flat, fully tighten all four nuts to secure the joining bars in place.

CHAIN HANGING - 2 × TRIPLE (3 × EMITTERS) HEATERS JOINED

 CAUTION 
Switch off/unplug the heater from the mains supply when mounting or adjusting the heater position.

- When two Alpha H3 heaters are joined they should only be hung from a ceiling on chains - do not wall mount!
- Always allow the heater to cool before attempting to reposition/move. Never attempt to move the heater while it is switched on!
- Observe the minimum safe distance between the heater body and inflammable surfaces and objects when mounting.
- Please refer to Table 1 for the recommended positioning of the heater with regards to minimum distances. Do not install the heater in a corner!
- Keep out of the reach of children.

1. Please refer to Table 1 for recommended positioning of the heater. When hanging from a ceiling two chains of equal length and gauge are required and should be selected with fixings that are adequate to hold the weight of the heater. If in doubt contact a professional for advice!

Continued on next page...

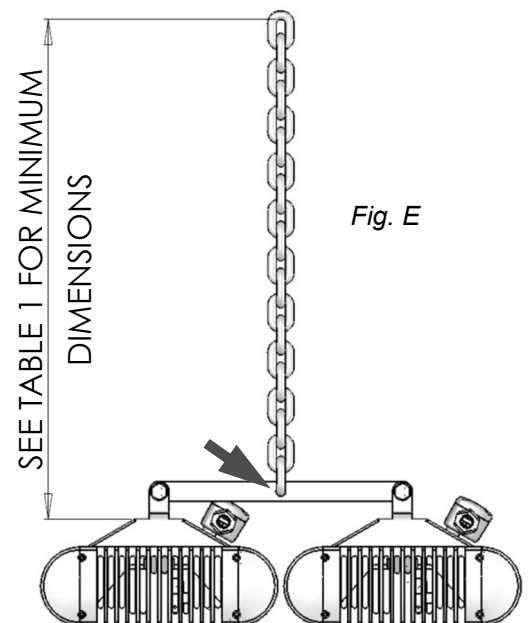

2. Fix the heater assembly to the chains via the hole in the centre of the joining bar as shown in Fig. E. and ensure the heaters face directly down when hanging.
3. Secure the supply cable so it is not resting on the body or obstructing the air-vents.

Always isolate the heater from the mains supply when adjusting the position.

MAINTENANCE

! NOTE: For replacement emitters or spare parts please contact your local distributor quoting model type and rating from rating label. It is very important that your replacement emitter is exactly the same as the one it was supplied with. Failure to fit the exact same type can cause the heater to prematurely fail.

⚠ CAUTION: Unplug/Switch off unit from the mains supply before replacing emitter or any maintenance procedure including cleaning.

⚠ CAUTION: Should dust or dirt appear on the reflector, it is recommended that the guard and emitter are removed and the reflector is wiped with a lint-free cloth before reassembling (see emitter replacement instructions).

REPLACING AN EMITTER

! CAUTION !

Unplug/switch off from the mains to the heater or heater assembly power before any attempts are made to replace the emitter. Contact your distributor for the correct replacement emitter quoting model type and rating from rating label. It is important that you read through the emitter replacement procedure before commencing.

1. Ensure the heater and emitter are cool and the power supply is disconnected or remove the plugs from the socket outlet - all plugs must be removed even if only one emitter is to be replaced.

2. Remove the screws from the terminal box at the back of the emitter to be replaced and lift off the lid - see Fig. F.



Fig. F

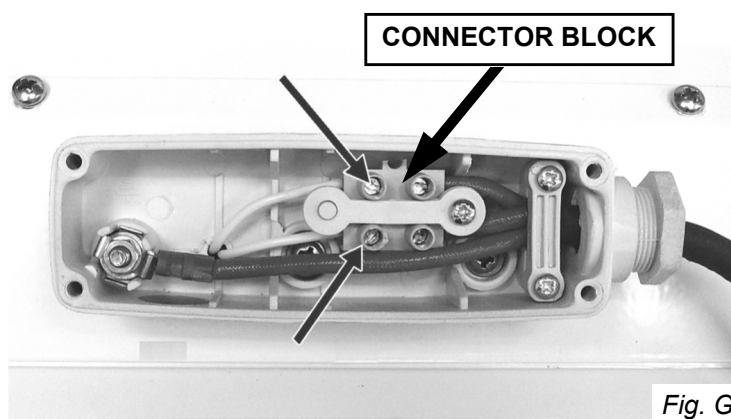
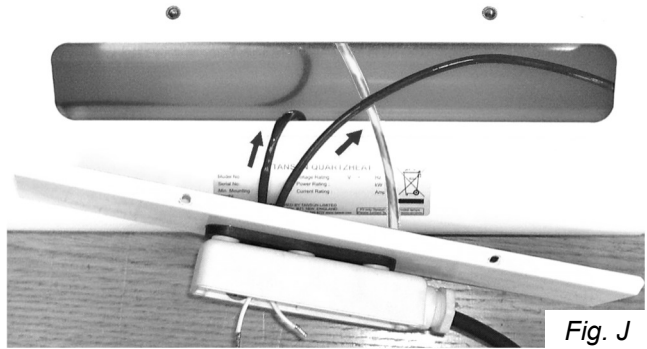
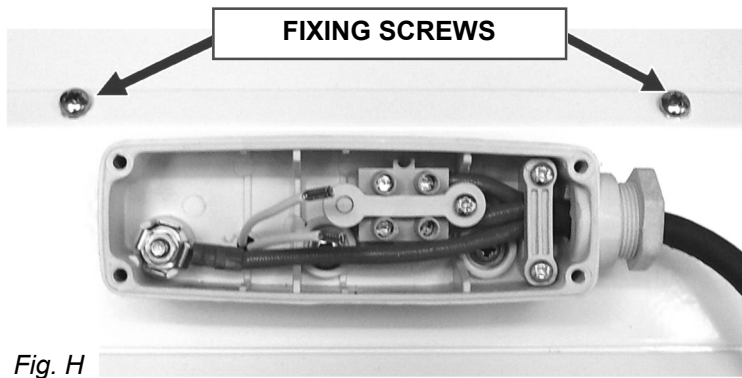

Fig. G

3. Disconnect the emitter from the connector block by unscrewing the screws highlighted above in Fig. G and remove the white coloured emitter wires from the connector block.

4. At the back of the heater, remove the plate holding the terminal box by removing the two fixing screws as shown in Fig. H.



5. Pull the emitter wires one at a time through the plate to remove as shown in Fig. J.

6. At the front of the heater, remove the grille bridging clamps as shown in Fig. K from both sides of the grille by undoing the centre screws and then remove the grille by pulling it out from the centre and prizing the prongs away from their locating holes at one end of the grille (Fig. L) and pull out of opposite end.

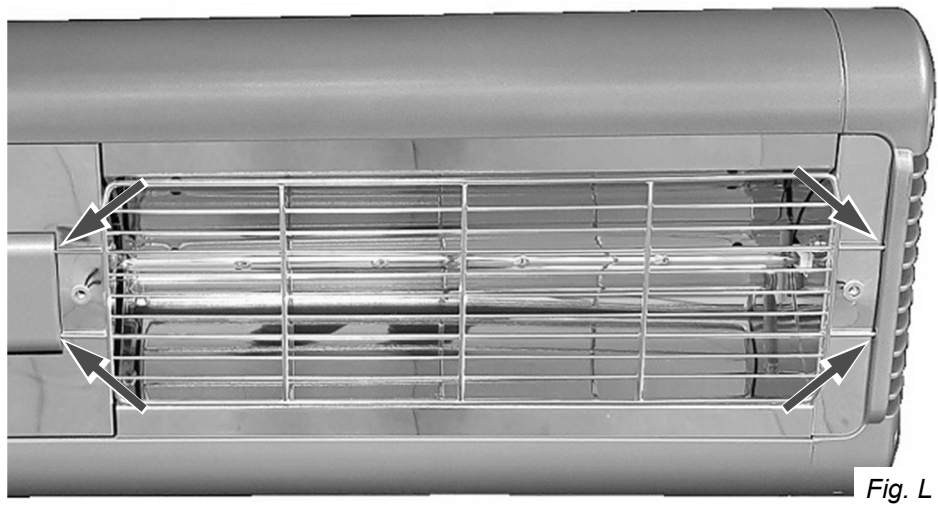

7. Remove the screws from the middle reflector on both sides (Fig. M) and the single screw from the side reflector (Fig. N). Lift them up and away from the heater to reveal the ceramic caps on the lamp emitters.

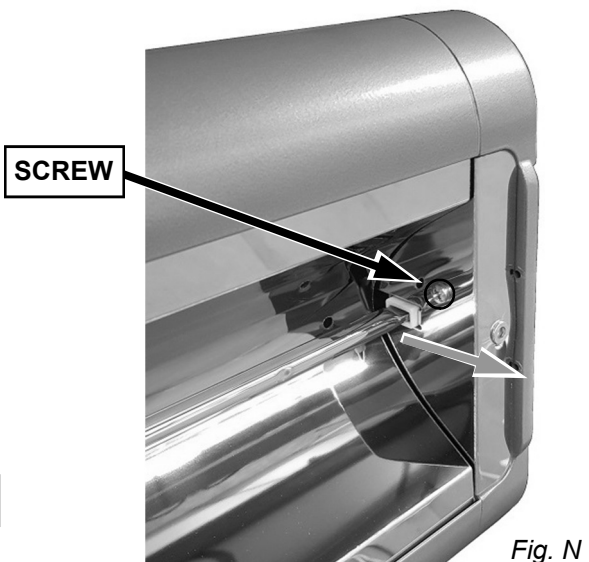
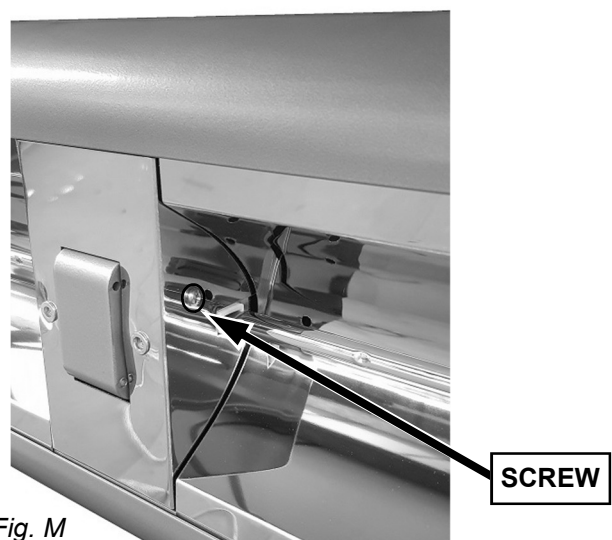

8. Release the lamp emitter end by pressing the top edge of the spring clip away from the lamp emitters ceramic end cap. Gently lift the end of the lamp emitter upwards so it is no longer being retained by the clip (Fig. P). The wire can then be gently pulled from behind the reflector.

9. The lamp emitter wire at the opposite end should be pulled out of the side slot (Fig. Q) and the lamp emitter can be lifted up completely. The wire can then be gently pulled forward so that it also comes out from behind the reflector.

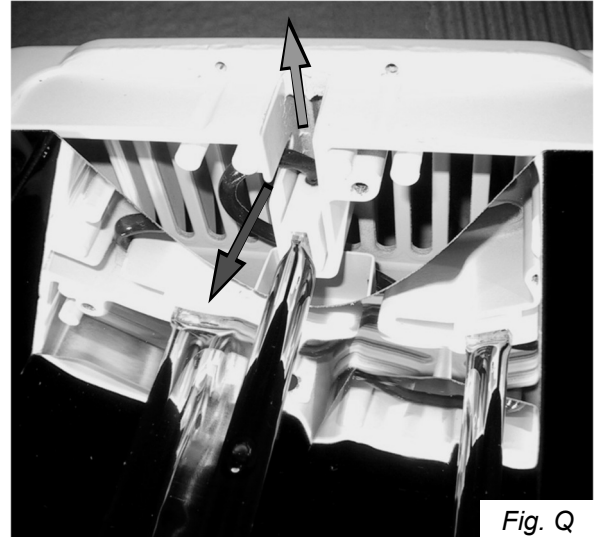
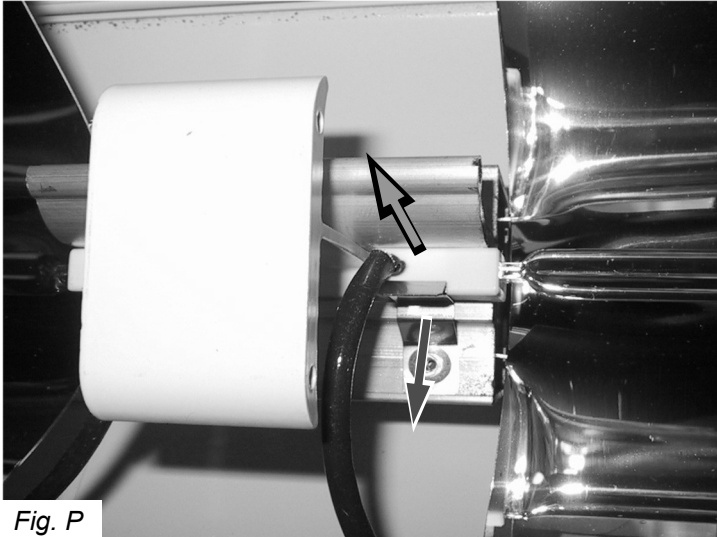

10. The emitter can now be removed away from the heater leaving it ready for the new emitter to be fitted as shown in Fig. R.



11. Refit the new emitter in reverse order making sure that no wires can get trapped. Replace the side reflectors/covers and their screws before any other parts are fitted to make sure the emitter is held safely.

Continued on next page...

12. Refit the grilles by taking a grille and inserting the 2 × prongs into the holes in the end of the heater (left side shown below in Fig. S) and gently flex the wire grille to insert the 2 × opposite prongs into the grille holder holes (to the other side of the lamp emitter as shown in Fig. T).

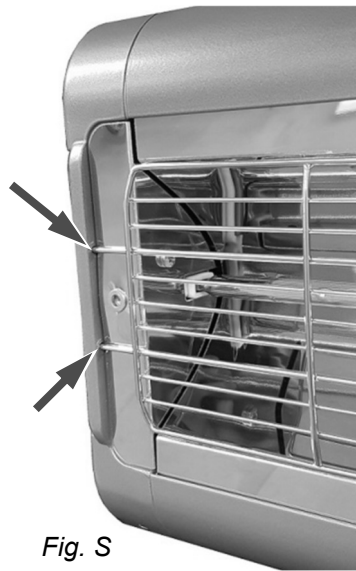

Fig. S



Fig. T

13. When fitting the middle grille, insert the 2 × prongs into the holes in the grille holder (Fig. U) and gently flex the grille to insert the 2 × opposite prongs into the opposite grille holder holes as shown in Fig. V.

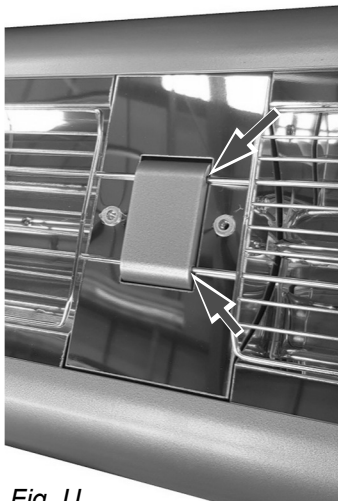

Fig. U

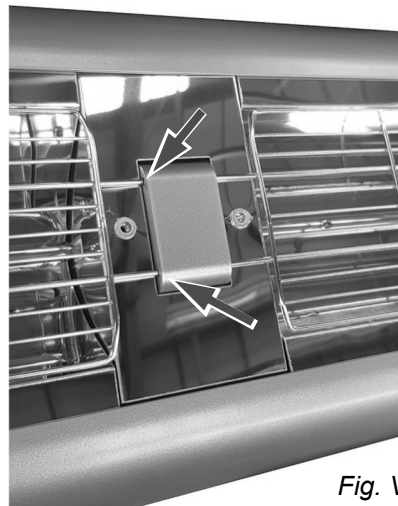

Fig. V

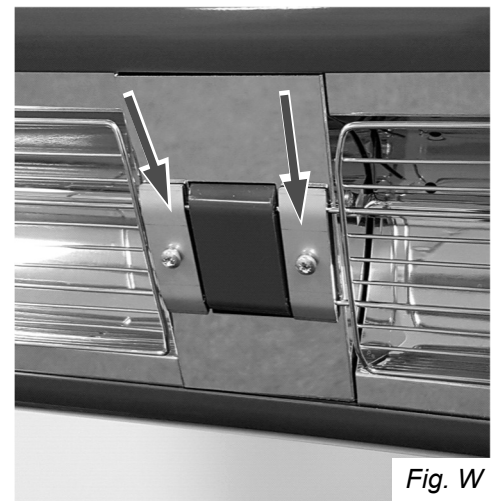

Fig. W

14. Refit the grille bridging pieces over the grille prongs as shown in Fig. W at the ends of the grilles.

15. Check the fitment of the grille by individually gripping them and moving them to their extreme left and right positions/pushing up and down to ensure they are all securely located (Fig. X).

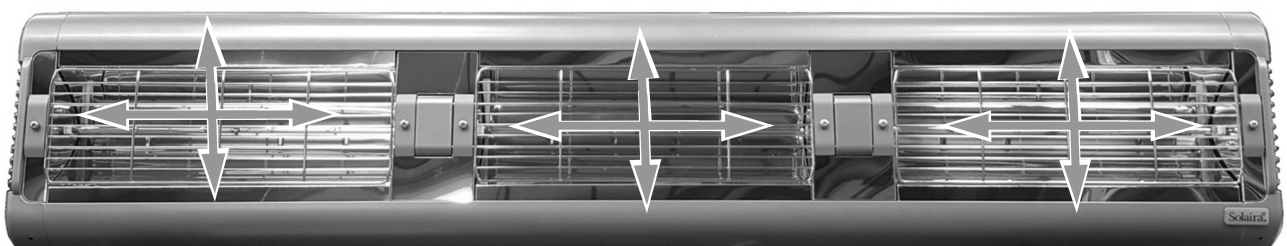
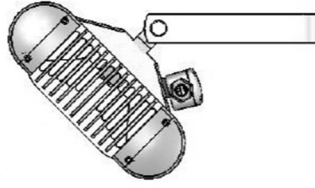

Fig. X

WALL MOUNTED CONFIGURATION - AT A GLANCE



1 × Alpha H2 Unit

CHAIN HANGING CONFIGURATIONS - AT A GLANCE

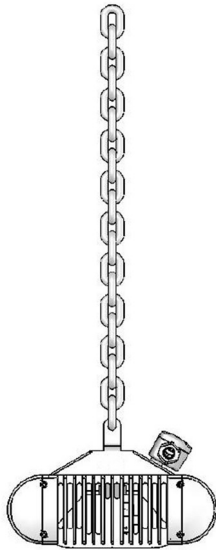

1 × Alpha H3 Unit

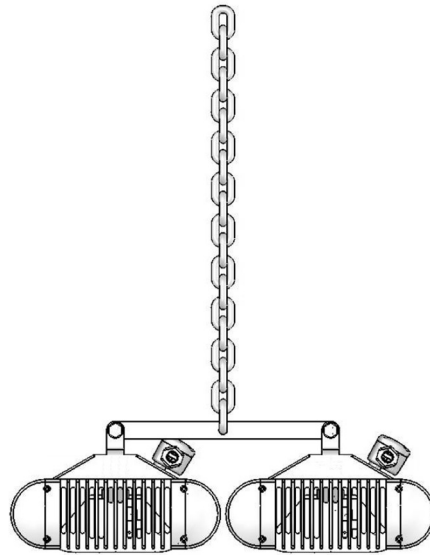

2 × Alpha H3 Units

Solaira Alpha H3

CANADA & USA MODELS:

SALPHAH3-30240LL-C (208V - 2250W / 240V - 3000W)

SALPHAH3-45240LL-C (208V - 3375W / 240V - 4500W)

SALPHAH3-60240LL-C (208V - 4500W / 240V - 6000W)

C = COLOR CODE



Also available in this range...

Solaira Alpha H1



Solaira Alpha H2

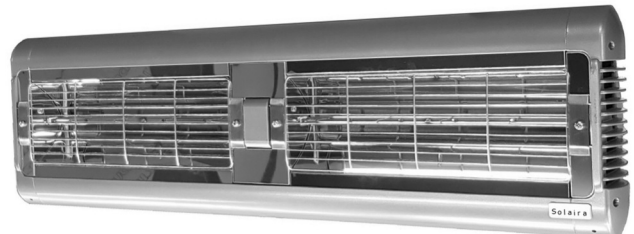

**IMPORTANT - SAVE THESE
INSTRUCTIONS FOR FUTURE REFERENCE**

INFORESIGHT CONSUMER PRODUCTS INC.

125 Traders Blvd. E Unit # 4, Mississauga, Ontario L4Z 2H3

Tel: 905-568-7655 - Fax: 905-568-7521

Email: info@solairaheaters.com - Website: www.solairaheaters.com



Due to our policy of ongoing improvement, we reserve the right to make changes without notice.

© 2020 INFORESIGHT CONSUMER PRODUCTS INC.

Ref No. 042226/L1 Issue No. 4